



PROTOTYPICAL

EFFECTIVE:

Jan 1, 2017

PAGE:

1 of 40

Sign Planogram: Patio Bay Name: Patio Furniture Laydown

Typical store layout for reference



The 3-tier fixture can be placed at the entrance of the Patio laydown OR on either side of the Patio laydown (depending on store layout).

3-Tier Fixture 1

T1	<h4>Patio Chat Sets</h4>	<h4>Gazebos</h4>	<p>See Page 9 for cover-up instructions</p>
	Top Tier (Front)	Top Tier (Back)	
T2	<h4>Patio Dining</h4>	<h4>Umbrellas</h4>	
	Middle Tier (Front)	Middle Tier (Back)	
T3	<h4>Fire Tables, Patio Heaters & Pits</h4>	<h4>Bistro</h4> <h4>Mix & Match</h4>	
	Front	Back	

Instructions:

- [3-Tier Signs] Insert top, middle and bottom Tier signs into 3-Tier Fixture



PROTOTYPICAL

Sign Planogram: Patio Bay Name: Patio Furniture Laydown

EFFECTIVE:

Jan 1, 2017

PAGE:

2 of 40

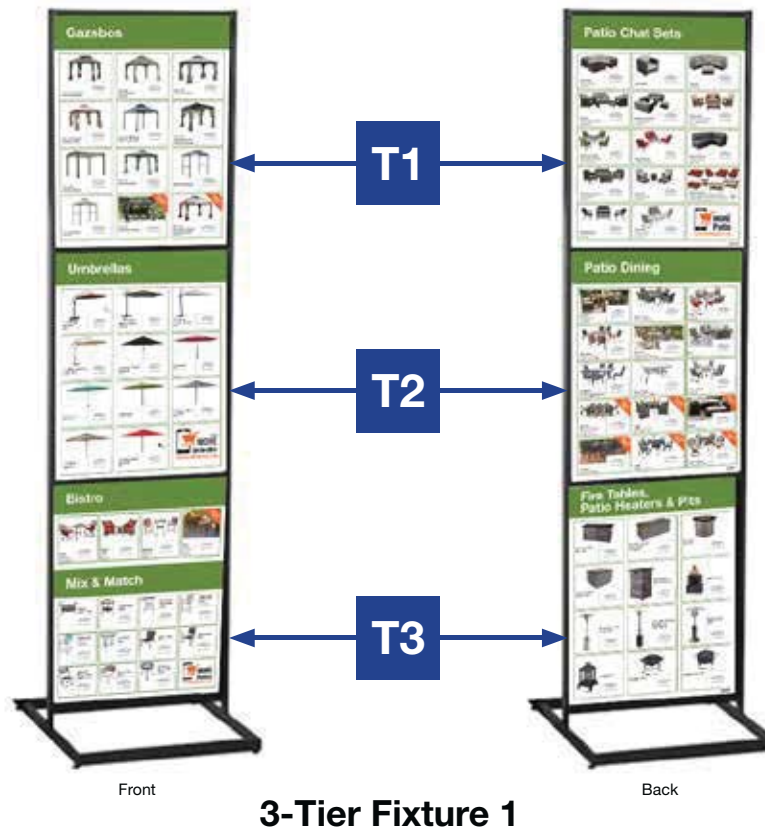

Laydown Signage Requirements

Item #	Part #	Description	Quantity	HD Article #	Hardware Requirements	How to Order
T1	HD2800002_026E	Patio Chat Sets - Tier Card (Front) Gazebo - Tier Card (Back)	1	1000847169/ 1000848556/ 1001025044 1000847059/ 1001025217/ 1000845506 1001025045/ 1001025041/ 1001025216 1000848299/ 1000683191/ 1001025043 1001024908 1001025208/ 1001025205/ 1001025207 1000811842/ 1000848292/ 1001025206 1001025204/ 1000848294/ 1001025209 1000812320/ 1001023535/ 1000797878	3-Tier Fixture	ePOP
T2	HD2800002_027E	Patio Dining - Tier Card (Front) Umbrellas -Tier Card (Back)	1	1000847058/ 1001025214/ 1001025219 1000845507/ 1001024914/ 1001025220 1001024911/ 1000752288/ 1000828571 1000862753/ 1000834404/ 1000832808 1000790767/ 1000835157/ 1000821151 1000814075/ 1001026244/ 1000845801 1001026238/ 1001026242/ 1000845807 1001026240/ 1001026241/ 1001025076 1001025074/ 1001025073	3-Tier Fixture	ePOP
T3	HD2800002_028E	Fire Tables, Patio Heaters & Pits - Tier Card (Front) Bistro, Mix & Match - Tier Card (Back)	1	1000847938/ 1001021889/ 1000847939 1001021890/ 1000847937/ 1001025116 1000540493/ 1000810235/ 1000800423 1001025115/ 1001025113/ 1001025114 1001025218/ 1001023108/ 1000845505 1000832600/ 1000847953/ 1000847954 1000846660/ 1000846657/ 1000846658 1000847083/ 1000847955/ 1001025005 1000847077/ 1000805848/ 1001024113	3-Tier Fixture	ePOP
-	CAN600002282	3-Tier Fixture	1	-	-	ePOP

Merchandising POG shown is for POP reference only and is not to be used to set product. Refer to your store specific Merchandise POG for product placement.



PROTOTYPICAL

Sign Planogram: Patio Bay Name: Patio Furniture Laydown

EFFECTIVE:
Jan 1, 2017

PAGE:
3 of 40



1 **Ann Arbor**
4-Piece Woven Sectional Set

- Fully upholstered seat
- 2-piece ottoman and end table
- Durable weather-resistant fabric
- Includes coordinating lumbar pillows for extra comfort
- 3-year limited warranty

Find this item: **ASLE** **547**

Coordinating items shown on reverse

2 **Crown View**
7-Piece Dining Set

- All weather soft fabric
- 2-piece ottoman and end table
- Durable weather-resistant fabric
- Includes coordinating lumbar pillows for extra comfort
- 3-year limited warranty

Find this item: **ASLE** **547**

Coordinating items shown on reverse

3 **St. Lucia**
7-Piece Sliding Dining Set

- Clear frames and table
- Durable weather-resistant fabric
- Includes coordinating lumbar pillows for extra comfort
- 3-year limited warranty

Find this item: **ASLE** **547**

Coordinating items shown on reverse

4 **St. Lucia**
4-Piece Sliding Chat Set

- Clear frames and table
- Durable weather-resistant fabric
- Includes coordinating lumbar pillows for extra comfort
- 3-year limited warranty

Find this item: **ASLE** **547**

Coordinating items shown on reverse

5 **Blue Hill**
4-Piece Woven Chat Set

- Heavy-duty 100% fabric for long-lasting durability
- Durable weather-resistant fabric
- Includes coordinating lumbar pillows for extra comfort
- 3-year limited warranty

Find this item: **ASLE** **547**

Coordinating items shown on reverse

6 **Machesney Park**
7-Piece Woven Chat Set

- Heavy-duty weather-resistant 100% fabric
- Durable weather-resistant fabric
- Includes coordinating lumbar pillows for extra comfort
- 3-year limited warranty

Find this item: **ASLE** **547**

Coordinating items shown on reverse

7 **Pleasantburg**
4-Piece Wicker Chat Set

- All weather soft fabric
- 2-piece ottoman and end table
- Durable weather-resistant fabric
- Includes coordinating lumbar pillows for extra comfort
- 3-year limited warranty

Find this item: **ASLE** **547**

Coordinating items shown on reverse

8 **Grand Prince**
4-Piece Woven Sectional

- Fully upholstered seat
- 2-piece ottoman and end table
- Durable weather-resistant fabric
- Includes coordinating lumbar pillows for extra comfort
- 3-year limited warranty

Find this item: **ASLE** **547**

Coordinating items shown on reverse

9 **Vestri**
7-Piece Dining Set

- Heavy-duty weather-resistant 100% fabric
- Durable weather-resistant fabric
- Includes coordinating lumbar pillows for extra comfort
- 3-year limited warranty

Find this item: **ASLE** **547**

Coordinating items shown on reverse

10 **Sky Breeze**
7-Piece Woven Dining Set

- All-weather mesh fabric
- Heavy-duty powder-coated steel frame
- Durable weather-resistant fabric
- Includes coordinating lumbar pillows for extra comfort
- 3-year limited warranty

Find this item: **ASLE** **547**

Coordinating items shown on reverse

11 **Tacana**
7-Piece Woven Dining Set

- All-weather soft fabric
- 2-piece ottoman and end table
- Durable weather-resistant fabric
- Includes coordinating lumbar pillows for extra comfort
- 3-year limited warranty

Find this item: **ASLE** **547**

Coordinating items shown on reverse

12 **Tacana**
4-Piece Woven Deep Seating Set

- Set includes 2 ottomans and 2 end tables
- Durable weather-resistant fabric
- Includes coordinating lumbar pillows for extra comfort
- 3-year limited warranty

Find this item: **ASLE** **547**

Coordinating items shown on reverse

13 **Kings Square**
4-Piece Chat Set

- Heavy-duty weather-resistant 100% fabric
- Durable weather-resistant fabric
- Includes coordinating lumbar pillows for extra comfort
- 3-year limited warranty

Find this item: **ASLE** **547**

Coordinating items shown on reverse

14 **Kings Square**
7-Piece Dining Set

- Heavy-duty weather-resistant 100% fabric
- Durable weather-resistant fabric
- Includes coordinating lumbar pillows for extra comfort
- 3-year limited warranty

Find this item: **ASLE** **547**

Coordinating items shown on reverse

15 **Kings Square**
3-Piece Motion High Bistro Set

- Powder-coated steel frame
- Heavy-duty weather-resistant 100% fabric
- Durable weather-resistant fabric
- Includes coordinating lumbar pillows for extra comfort
- 3-year limited warranty

Find this item: **ASLE** **547**

Coordinating items shown on reverse

16 **Redwood Valley**
5-Piece Deep Seating Set

- Heavy-duty weather-resistant 100% fabric
- Durable weather-resistant fabric
- Includes coordinating lumbar pillows for extra comfort
- 3-year limited warranty

Find this item: **ASLE** **547**

Coordinating items shown on reverse

17 **Spring Haven**
Collection

- All-weather soft fabric
- 2-piece ottoman and end table
- Durable weather-resistant fabric
- Includes coordinating lumbar pillows for extra comfort
- 3-year limited warranty

Find this item: **ASLE** **547**

See reverse for individual prices

Instructions:

- [Tent Card] Use pre-applied tape to form the base of the tent card. Place tent card in centre of table and secure with double-sided tape on bottom.



PROTOTYPICAL

Sign Planogram: Patio Bay Name: Patio Furniture Laydown

EFFECTIVE:

Jan 1, 2017

PAGE:

4 of 40



Note: Pictures from IC set for visual inspiration and decorating suggestions

Laydown Signage Requirements

Item #	Part #	Description	Quantity	HD Article #	Hardware Requirements	How to Order
1	HD2800002_045E	Ann Arbor 4-Piece Woven Sectional Set - Tent Card	1	1000847169 1000848556	-	ePOP
2	HD2800002_046E	Crown View 7-Piece Dining Set - Tent Card	1	1001025214 1001025215	-	ePOP
3	HD2800002_047E	St. Lucia 7-Piece Sling Dining Set- Tent Card	1	1001024914 1001024908	-	ePOP
4	HD2800002_048E	St. Lucia 4-Piece Sling Chat Set - Tent Card	1	1001024908 1001024914	-	ePOP
5	HD2800002_049E	Blue Hill 5-Piece Woven Chat Set - Tent Card	1	1000683191	-	ePOP
6	HD2800002_050E	Machesney Park 5-Piece Woven Chat Set - Tent Card	1	1001025217	-	ePOP
7	HD2800002_051E	Pleasantburg 4-Piece Wicker Chat Set - Tent Card	1	1001025043	-	ePOP
8	HD2800002_052E	Grand Prince 4-Piece Woven Sectional - Tent Card	1	1001025216	-	ePOP
9	HD2800002_053E	Vestri 7-Piece Dining Set - Tent Card	1	1001025220	-	ePOP
10	HD2800002_054E	Sky Breeze 7-Piece Woven Dining Set - Tent Card	1	1001024911	-	ePOP
11	HD2800002_055E	Tacana 7-Piece Woven Dining Set - Tent Card	1	1000847058 1000850728 1000850729 1001025044 1000847059 1000847055	-	ePOP
12	HD2800002_056E	Tacana 4-Piece Woven Deep Seating Set - Tent Card	1	1000847059	-	ePOP
13	HD2800002_057E	Kings Square 4-Piece Chat Set - Tent Card	1	1001025041 1001025218 1001025219	-	ePOP
14	HD2800002_058E	Kings Square 7-Piece Dining Set - Tent Card	1	1001025219 1001025218 1001025041	-	ePOP
15	HD2800002_059E	Kings Square 3-Piece Motion High Bistro Set - Tent Card	1	1001025218 1001025219 1001025041	-	ePOP
16	HD2800002_060E	Redwood Valley 5-Piece Deep Seating Set - Tent Card	1	1001025045	-	ePOP
17	HD2800002_061E	Spring Haven Collection - Tent Card	1	1001021902 1001021898 1001021901 1001021897 1001021900 1001021896 1001021894 1001021899 1001021895 1001021087	-	ePOP

Merchandising POG shown is for POP reference only and is not to be used to set product. Refer to your store specific Merchandise POG for product placement.



PROTOTYPICAL

Sign Planogram: Patio Bay Name: Patio Furniture Laydown

EFFECTIVE:

Jan 1, 2017

PAGE:

5 of 40

18



See Page 9
for cover-up
instructions

See Page 9
for cover-up
instructions



Install Gazebo Legwrap on front left leg of FIRST gazebo in the main aisle



View of stabilizer inside Gazebo Legwrap

Instructions for Pole Stabilizer Supports:

Use the 4 pieces of the corrugate supports supplied with gazebo legwrap POP to form pole stabilizers with zip ties provided. (See images to the left for reference.) Pull zip ties together to tighten.



Instructions:

- [Gazebo Legwrap] Fold wrap along creases and wrap around gazebo leg, securing with pre-applied double-sided tape. Use the pole stabilizer supports provided to hold the leg structure together (see above for reference).

Laydown Signage Requirements

Item #	Part #	Description	Quantity	HD Article #	Hardware Requirements	How to Order
18	HD2800002_076E	Gazebo Legwrap	1	1001025208/ 1001025205/ 1001025204 1000848292/ 1001025207/ 1001025206 1001025209/ 1000812320/ 1000811842 1000848294/ 1001023535/ 1000797878		ePOP

Merchandising POG shown is for POP reference only and is not to be used to set product. Refer to your store specific Merchandise POG for product placement.



PROTOTYPICAL

**Sign Planogram: Patio
Bay Name: Patio Furniture Laydown**

EFFECTIVE:

Jan 1, 2017

PAGE:

6 of 40

Gazebo POP:



Patio Heater/Fire Table POP:



Additional POP:



NOTE: Spring Haven (Grand Basket) and Redwood Valley (Yotrio) Sets will get the additional colour features available online hang card

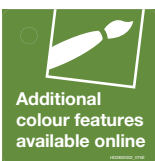

Instructions:

- [Hang Tags] Attach hang tags to product display using zip tie.

Laydown Signage Requirements

Item #	Part #	Description	Quantity	HD Article #	Hardware Requirements	How to Order
19	HD2800002_015E	Arched Pergola 10' x 10' - Hang Card	1	1001025204	-	ePOP
20	HD2800002_017E	Hard Top Gazebo 10' x 12' - Hang Card	1	1001025208	-	ePOP
21	HD2800002_002E	Faux Concrete Fire Table - Hang Card	1	1001021889	-	ePOP
22	HD2800002_003E	Rectangle Fire Table - Hang Card	1	1000847938	-	ePOP
23	HD2800002_005E	Stainless Steel Patio Heater - Hang Card	1	1000540493	-	ePOP
24	HD2800002_006E	Table Top Patio Heater - Hang Card	1	1000800423	-	ePOP
25	HD2800002_007E	Patio Heater - Hang Card	1	1000810235	-	ePOP
26	HD2800002_008E	30" Black Slate Fire Pit - Hang Card	1	1001025113	-	ePOP
27	HD2800002_009E	Slate Fireplace - Hang Card	1	1001025116	-	ePOP
	GA002C	Zip Ties	Varies	-	-	ePOP

Merchandising POG shown is for POP reference only and is not to be used to set product. Refer to your store specific Merchandise POG for product placement.



PROTOTYPICAL

Sign Planogram: Patio Bay Name: Patio Furniture Laydown

EFFECTIVE:

Jan 1, 2017

PAGE:

7 of 40

21 9' EZ Tilting Umbrella
Grey



2" x 1.25" price label
Article # 1000846921
Model # UMB-922120



22 9' Umbrella
Brown



2" x 1.25" price label
Article # 1000845805
Model # 270-9-38A-BR



23 9' Umbrella
Haze (Teal)



2" x 1.25" price label
Article # 1001026240
Model # 270-9-38A-TE



24 9' Umbrella
Luxe (Green)



2" x 1.25" price label
Article # 1001026241
Model # 270-9-38A-GR



25 9' Umbrella
Red



2" x 1.25" price label
Article # 1000845807
Model # 270-9-38A-RED



26 9' Wooden Market Umbrella
Black



2" x 1.25" price label
Article # 1001026242
Model # 270-6-38W



27 7.5' Steel Market Umbrella
Red



2" x 1.25" price label
Article # 1001025073
Model # UTS00201E-RED



28 7.5' Market Umbrella
Grey



2" x 1.25" price label
Article # 1001025076
Model # UTS00203E-GREY



29 7.5' Market Umbrella
Tan



2" x 1.25" price label
Article # 1001025074
Model # UTS00203E-TAN



30 7.5' Steel Market Umbrella
Black



2" x 1.25" price label
Article # 1001025075
Model # UTS00203E-BLACK



EZ

0	0	0	0	0	0	0	0
1	1	1	1	1	1	1	1
2	2	2	2	2	2	2	2
3	3	3	3	3	3	3	3
4	4	4	4	4	4	4	4
5	5	5	5	5	5	5	5
6	6	6	6	6	6	6	6
7	7	7	7	7	7	7	7
8	8	8	8	8	8	8	8
9	9	9	9	9	9	9	9

31 Offset Umbrellas



Instructions:

- [Offset Umbrella Product Card] Use zip ties to apply the product card to its corresponding umbrella. Stores are to use the middle punch mark in order to achieve the same execution as the IC set.
- [Product label] Adhere label to surface of umbrella base blocks (article # 1000721260).
- [EZ Find stickers] Add to base blocks label.

Laydown Signage Requirements

Item #	Part #	Description	Quantity	HD Article #	Hardware Requirements	How to Order
21	HD2800002_062E	9' EZ Tilting Umbrella Grey - Product Card	1	1000846921	-	ePOP
22	HD2800002_063E	9' Umbrella Brown - Product Card	1	1000845805	-	ePOP
23	HD2800002_064E	9' Umbrella Haze (Teal) - Product Card	1	1001026240	-	ePOP
24	HD2800002_065E	9' Umbrella Luxe (Green) - Product Card	1	1001026241	-	ePOP
25	HD2800002_066E	9' Umbrella Red - Product Card	1	1000845807	-	ePOP
26	HD2800002_067E	9' Wooden Market Umbrella Black - Product Card	1	1001026242	-	ePOP
27	HD2800002_068E	7.5' Steel Market Umbrella Red - Product Card	1	1001025073	-	ePOP
28	HD2800002_069E	7.5' Market Umbrella Grey - Product Card	1	1001025076	-	ePOP
29	HD2800002_070E	7.5' Market Umbrella Tan - Product Card	1	1001025074	-	ePOP
30	HD2800002_071E	7.5' Steel Market Umbrella Black - Product Card	1	1001025075	-	ePOP
31	HD2800002_072E	Offset Umbrellas - Product Card	1	1000811570 1000814075 1000845801 1001026238 1001026244 1001026239 1001024907	Zip Ties	ePOP
EZ	EZFind-0-9	Wayfinding Number Stickers	-	-	-	ePOP
	GA002C	11" Black Zip Ties	2	-	-	ePOP

Merchandising POG shown is for POP reference only and is not to be used to set product. Refer to your store specific Merchandise POG for product placement.



PROTOTYPICAL

Sign Planogram: Patio Furniture Bay Name: Patio Laydown

EFFECTIVE:
Mar 23, 2017

PAGE:
8 of 40

Other POP Available:

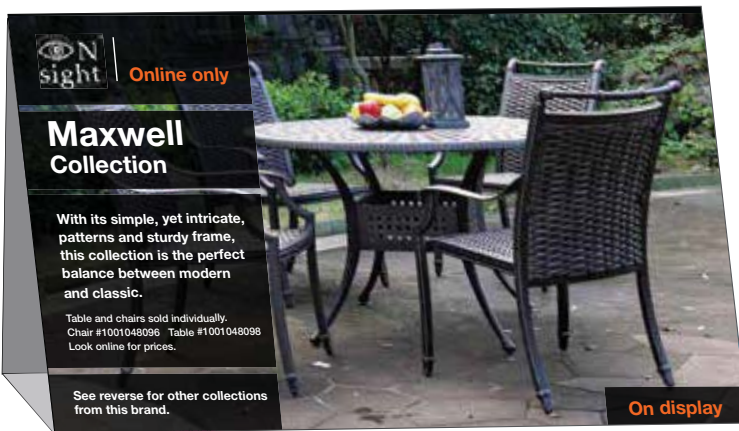

Note: Execution window - April MET

Instructions:

- [Tent Card] Use pre-applied tape to form the base of the tent card. Place tent card in centre of table and secure with double-sided tape on bottom.



PROTOTYPICAL

Sign Planogram: Patio Furniture Bay Name: Patio Laydown

EFFECTIVE:

Jan 1, 2017

PAGE:

9 of 40

Sticker Sheet Cover-Up Instructions:

SS

SPRING EVENT STICKER INSTALLATION INSTRUCTIONS

Stickers

- 3 per store
- Peel and place sticker 1 within the 10' x 12' General Netting Gazebo square on the 3-tier tower poster as shown below.
- Peel and place sticker 2 within the 10' x 12' General Netting Gazebo square on the Leg Wrap as shown below.
- Peel and place sticker 3 within the Arched Pergola square to cover the dimensions (9' x 9')

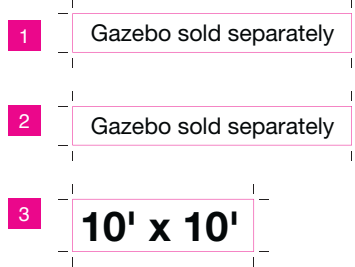

3 Tier Poster



Leg Wrap

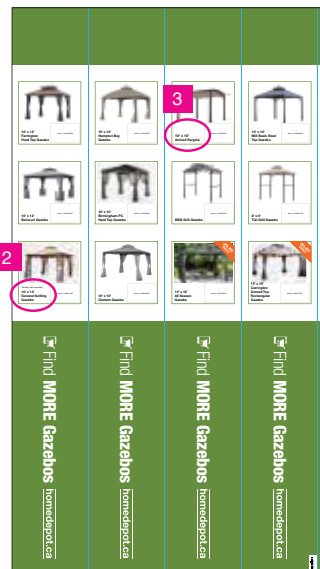

HD2800029_002E

Instructions:

- [Sticker Sheet] Refer to Instruction sheet for cover-up instructions

Signage Requirements

Item #	Part #	Description	Quantity	HD Article #	Hardware Requirements	How to Order
SS	HD2800029_002E	Spring Event Sticker Installation Instructions	1	-	-	ePOP

Merchandising POG shown is for POP reference only and is not to be used to set product. Refer to your store specific Merchandise POG for product placement.



PROTOTYPICAL

**Sign Planogram: Patio
Bay Name: Other POP Available**

EFFECTIVE:

Jan 1, 2017

PAGE:

10 of 40



LG



In Bay Signage Requirements

Item #	Part #	Description	Quantity	HD Article #	Hardware Requirements	How to Order
LG	-	Lava Glass Sign	1	-	-	ePOP

Merchandising POG shown is for POP reference only and is not to be used to set product. Refer to your store specific Merchandise POG for product placement.



PROTOTYPICAL

Sign Planogram: Patio Bay Name: Patio Furniture Laydown

EFFECTIVE:

Jan 1, 2017

PAGE:

11 of 40



Locate article 1001035476 (7'x11' outdoor rug); article can be found in the outdoor rug QP.

This will be executing in roughly 80 stores.



PROTOTYPICAL

Sign Planogram: Patio Bay Name: Gazebos

EFFECTIVE:

Jan 1, 2017

PAGE:

12 of 40

WF Wayfinding bay number must correspond to bay ID label

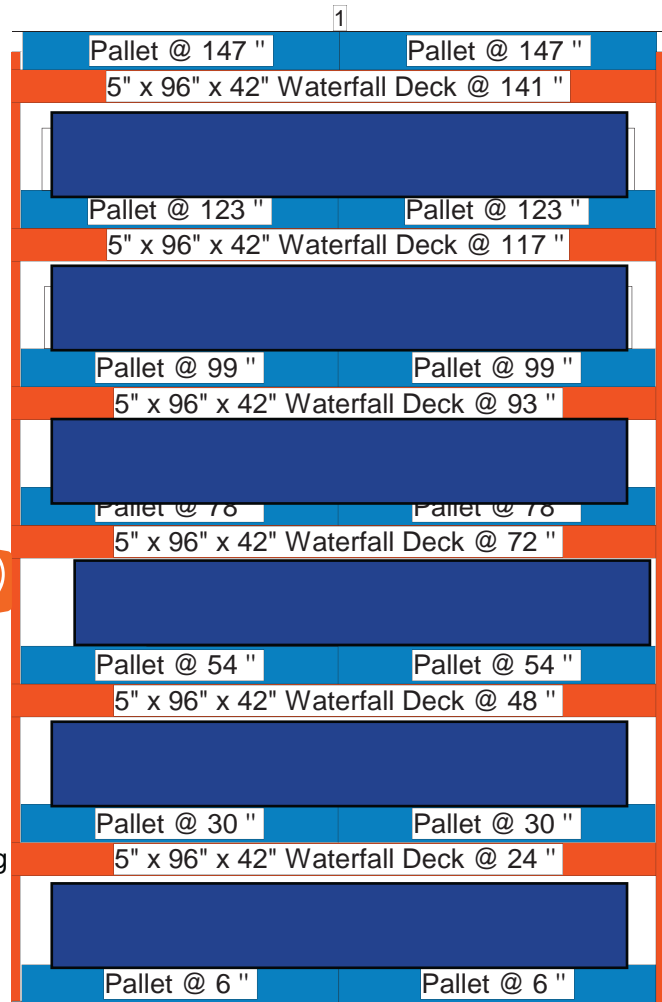
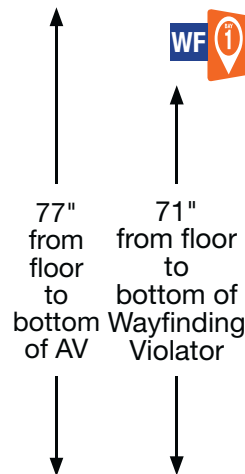

Instructions:

- [Wayfinding Violator] Install Wayfinding Violator using wayfinding clip so bottom edge is 71" above the floor

In Bay Signage Requirements

Item #	Part #	Description	Quantity	HD Article #	Hardware Requirements	How to Order
WF	Varies by bay ID #	Wayfinding Violator	1	-	Wayfinding Clip	ePOP
-	124-300TESA	Wayfinding Clip	1	-	-	ePOP

Merchandising POG shown is for POP reference only and is not to be used to set product. Refer to your store specific Merchandise POG for product placement.



PROTOTYPICAL

Sign Planogram: Patio Bay Name: Fire Pits & Heaters

EFFECTIVE:

Jan 1, 2017

PAGE:

13 of 40

WF Wayfinding bay number must correspond to bay ID label



Wayfinding Clip

Note: The three firepits displayed in the overhead elevation do not get product cards, please print Long Hang Tags



71"
from floor
to
bottom of
Wayfinding
Violator

Photo is for reference only and may not reflect your store merchandising. Refer to POG for proper configuration.

Instructions:

- [Wayfinding Violator] Install Wayfinding Violator using wayfinding clip so bottom edge is 71" above the floor



PROTOTYPICAL

Sign Planogram: Patio Bay Name: Fire Pits & Heaters

EFFECTIVE:

Jan 1, 2017

PAGE:

14 of 40

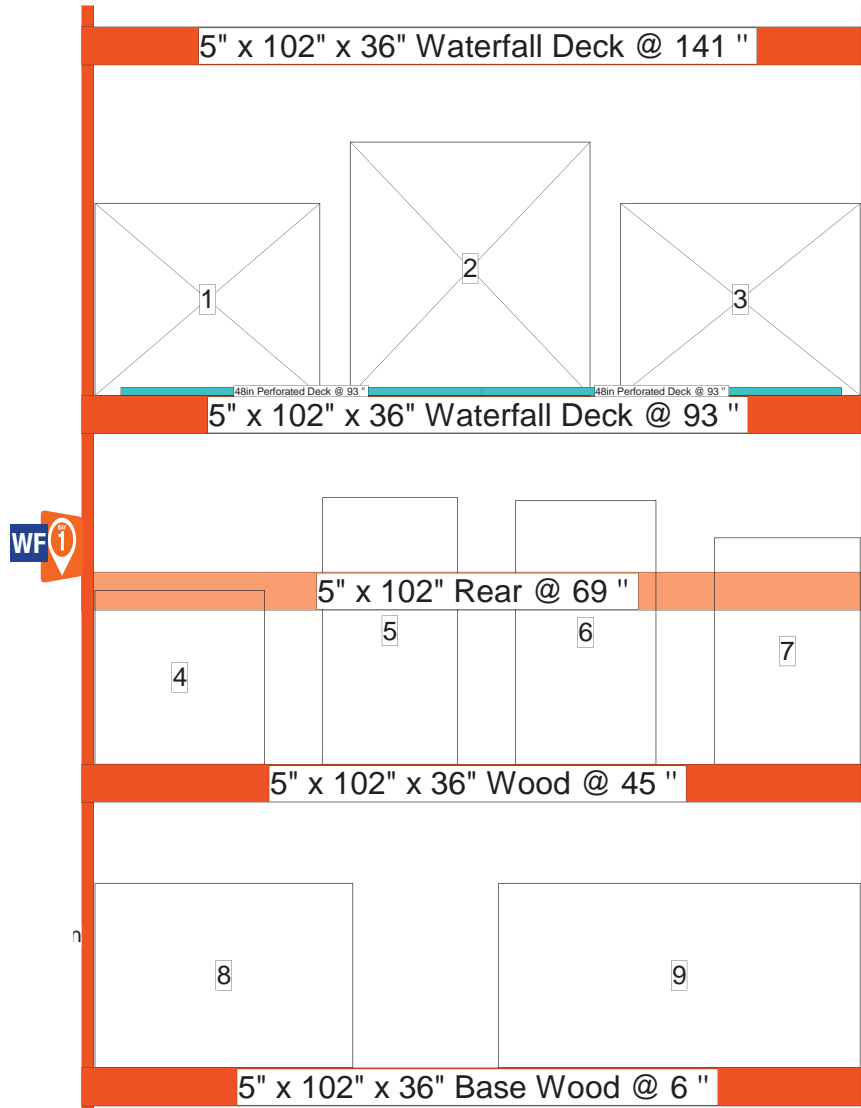

In Bay Signage Requirements

Item #	Part #	Description	Quantity	HD Article #	Hardware Requirements	How to Order
WF	Varies by bay ID #	Wayfinding Violator	1	-	Wayfinding Clip	ePOP
-	124-300TESA	Wayfinding Clip	1	-	-	ePOP

Merchandising POG shown is for POP reference only and is not to be used to set product. Refer to your store specific Merchandise POG for product placement.

34

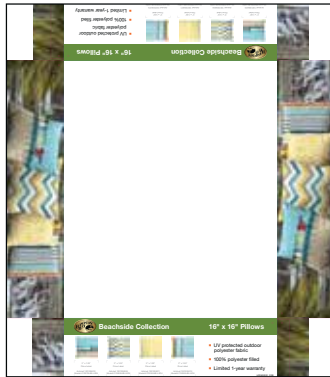

34



35



35

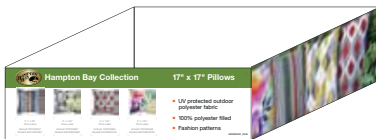

36



36

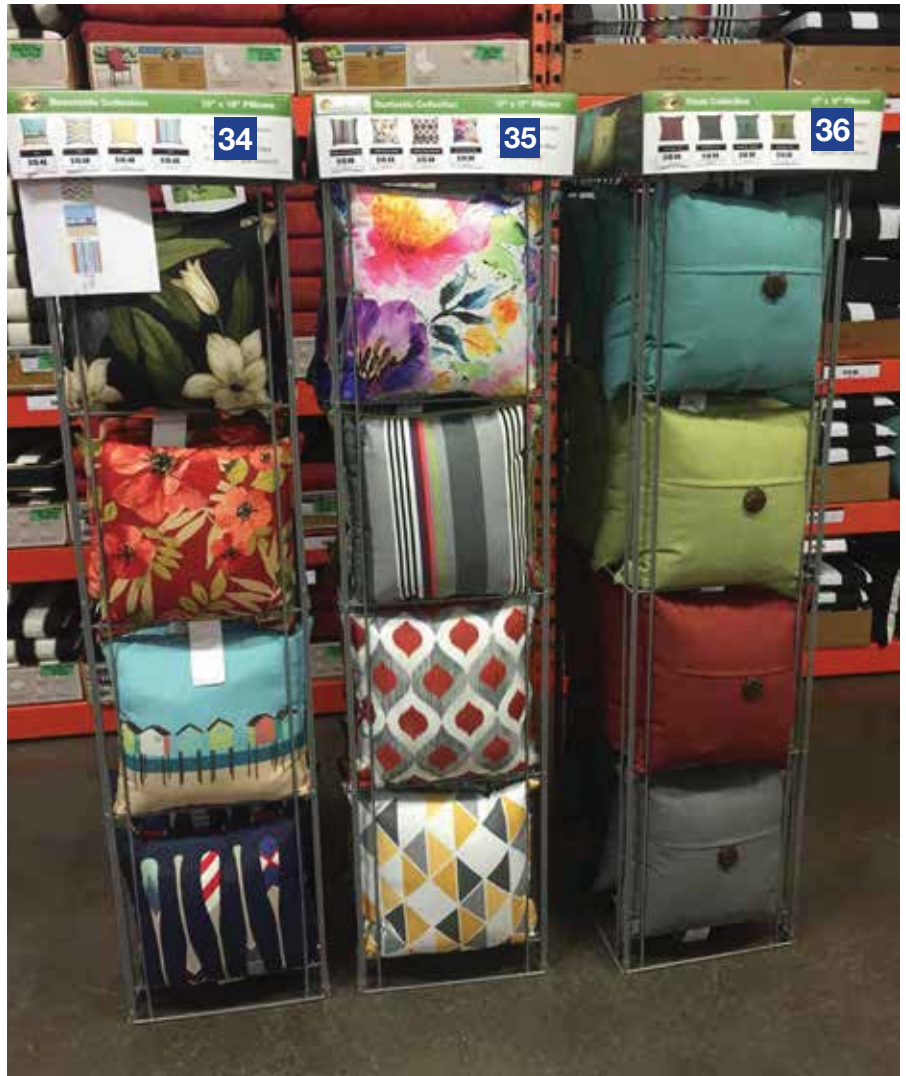

Instructions:

- [Pillow Toppers] Attach pillow topper on top of appropriate cushion tower.



PROTOTYPICAL

**Sign Planogram: Patio
Bay Name: Pillow Towers**

EFFECTIVE:

Jan 1, 2017

PAGE:

16 of 40

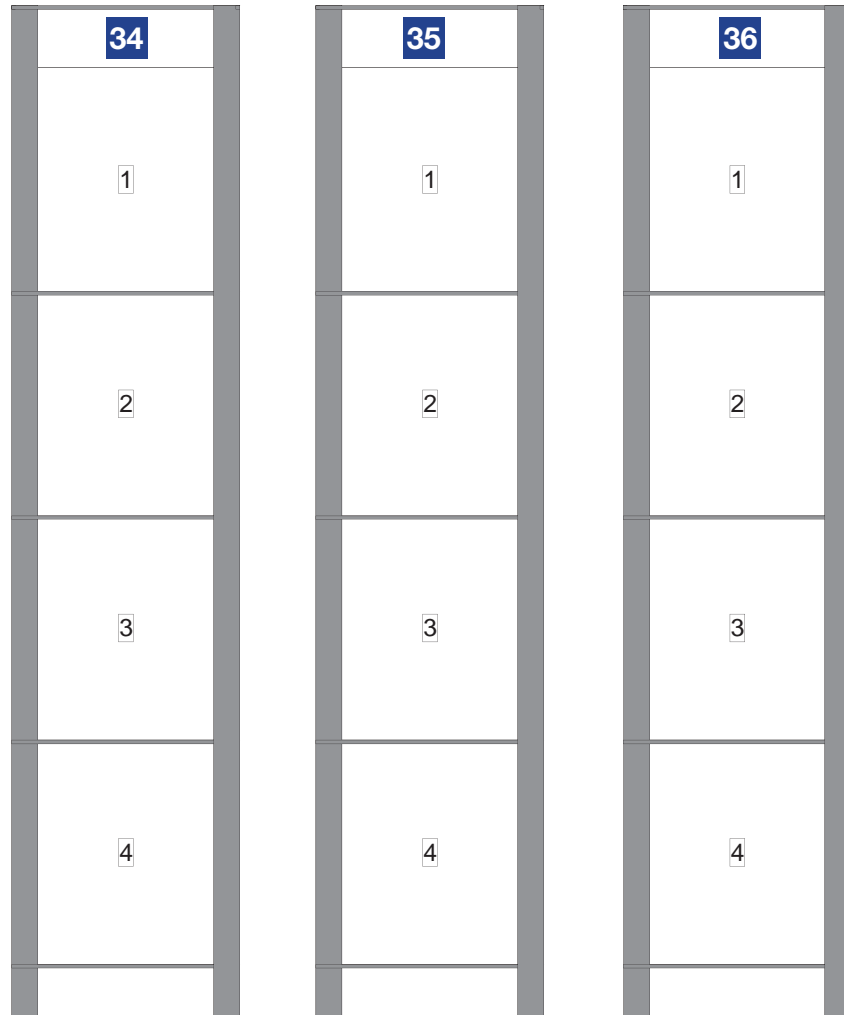

In Bay Signage Requirements

Item #	Part #	Description	Quantity	HD Article #	Hardware Requirements	How to Order
34	HD2800002_033E	Beachside Collection Cushion Tower Sign	1	1001026911 1001026904 1001026910 1001026274	-	ePOP
35	HD2800002_034E	Hampton Bay Collection Cushion Tower Sign	1	1001028468 1001030037 1001029884 1001029867	-	ePOP
36	HD2800002_032E	Button Pillow Collection Cushion Tower Sign	1	1001030060 1001030046 1001029877 1001029878	-	ePOP

Merchandising POG shown is for POP reference only and is not to be used to set product. Refer to your store specific Merchandise POG for product placement.



PROTOTYPICAL

Sign Planogram: Patio Bay Name: Patio Mix N Match 2.1

EFFECTIVE:

Jan 1, 2017

PAGE:

17 of 40

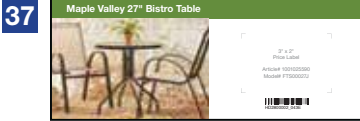

SN
All Displays
Stacked
Below



71"
from floor
to bottom
of
Wayfinding
Violator



WF Wayfinding bay number must correspond to bay ID label



Instructions:

- [Wayfinding Violator] Install Wayfinding Violator using wayfinding clip so bottom edge is 71" above the floor
- [Beam Label] Remove any old beam labels (if applicable) and place label on the beam below the applicable product



PROTOTYPICAL

Sign Planogram: Patio Bay Name: Patio Mix N Match 2.1

EFFECTIVE:

Jan 1, 2017

PAGE:

18 of 40

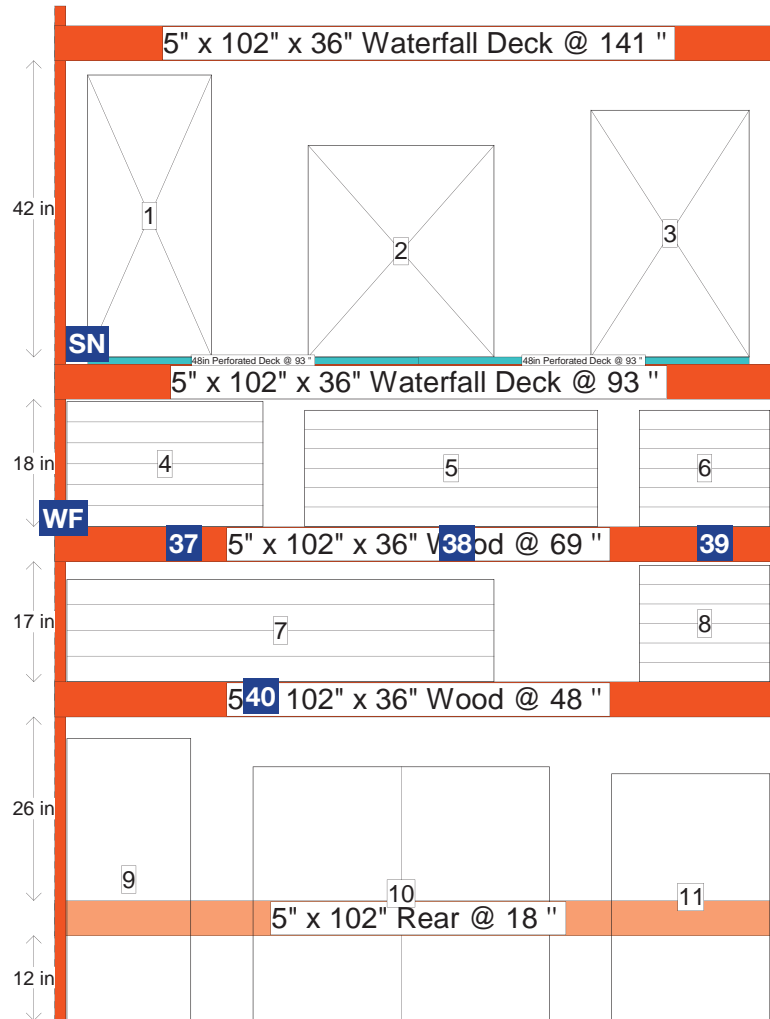

In Bay Signage Requirements

Item #	Part #	Description	Quantity	HD Article #	Hardware Requirements	How to Order
37	HD2800002_043E	Maple Valley 27" Bistro Table - Beam Label	1	1001025590	-	ePOP
38	HD2800002_039E	Maple Valley 42" x 42" Dining Table - Beam Label	1	1001025191	-	ePOP
39	HD2800002_041E	Maple Valley 18" x 18" Side Table - Beam Label	1	1001025589	-	ePOP
40	HD2800002_038E	Maple Valley 60" x 38" Dining Table - Beam Label	1	1001025190	-	ePOP
SN	HD2800002_012E	All displays stocked below - Snipe	1	-	Clip	ePOP
WF	Varies by bay ID #	Wayfinding Violator	1	-	Wayfinding Clip	ePOP
-	124-300TESA	Wayfinding Clip	1	-	-	ePOP

Merchandising POG shown is for POP reference only and is not to be used to set product. Refer to your store specific Merchandise POG for product placement.



PROTOTYPICAL

Sign Planogram: Patio Bay Name: Patio Mix N Match 2.2

EFFECTIVE:

Jan 1, 2017

PAGE:

19 of 40



SN
All Displays
Stacked
Below



71"
from floor
to bottom
of
Wayfinding
Violator

WF Wayfinding bay
number must
correspond to
bay ID label



Wayfinding
Clip

Instructions:

- [Wayfinding Violator] Install Wayfinding Violator using wayfinding clip so bottom edge is 71" above the floor
- [Beam Label] Remove any old beam labels (if applicable) and place label on the beam below the applicable product



PROTOTYPICAL

Sign Planogram: Patio Bay Name: Patio Mix N Match 2.2

EFFECTIVE:

Jan 1, 2017

PAGE:

20 of 40

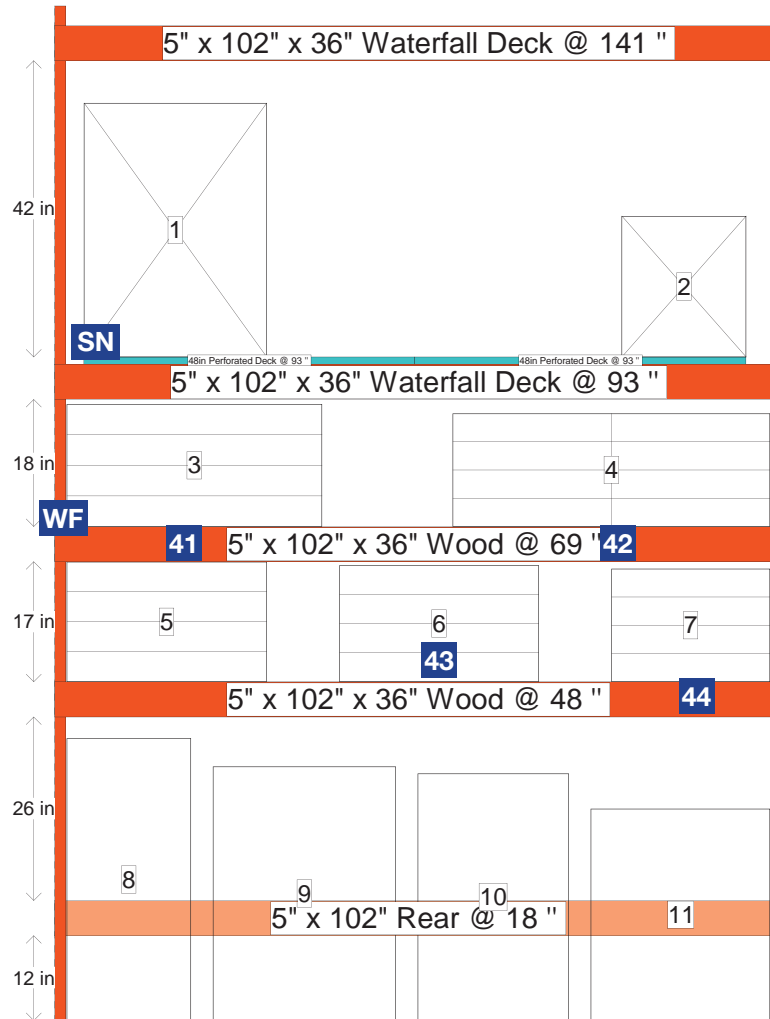

In Bay Signage Requirements

Item #	Part #	Description	Quantity	HD Article #	Hardware Requirements	How to Order
41	HD2800002_042E	36" Round Table with Slat Top - Beam Label	1	1001025588	-	ePOP
42	HD2800002_044E	22" Round Table with Slat Top - Beam Label	1	1001025587	-	ePOP
43	HD2800002_036E	Arthur Side Table - Beam Label	1	1000847954	-	ePOP
44	HD2800002_035E	Margie Woven 16" Side Table - Beam Label	1	1001024113	-	ePOP
SN	HD2800002_012E	All displays stocked below - Snipe	1	-	Clip	ePOP
WF	Varies by bay ID #	Wayfinding Violator	1	-	Wayfinding Clip	ePOP
-	124-300TESA	Wayfinding Clip	1	-	-	ePOP

Merchandising POG shown is for POP reference only and is not to be used to set product. Refer to your store specific Merchandise POG for product placement.



PROTOTYPICAL

Sign Planogram: Patio Bay Name: Patio Accessories 3.1

EFFECTIVE:

Jan 1, 2017

PAGE:

21 of 40

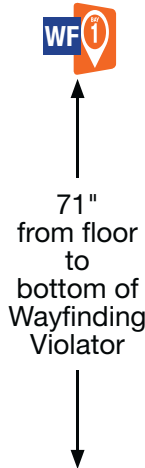
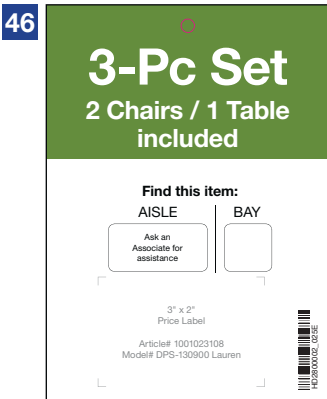
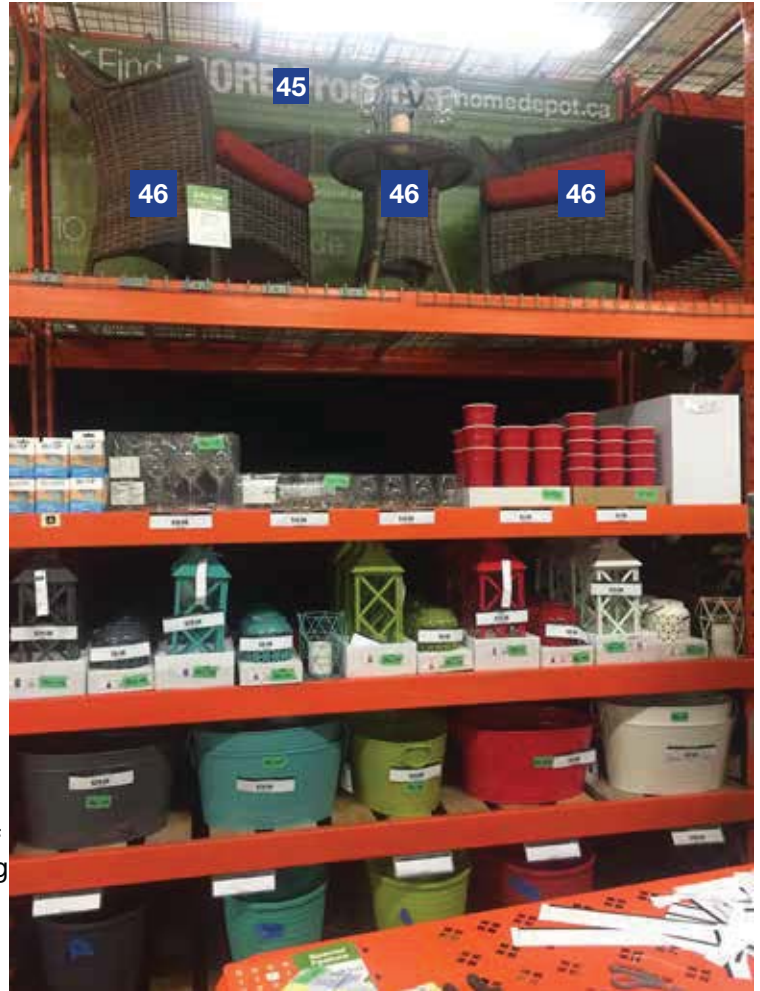

WF Wayfinding bay number must correspond to bay ID label



Instructions:

- [Wayfinding Violator] Install Wayfinding Violator using wayfinding clip so bottom edge is 71" above the floor
- [Banner] Attach banner to uprights using zip ties through grommets in corners
- [3-Piece Set] The 3-piece set is decorated with 2 wine glasses from the Wine Glasses Set of 4 – Tritan (1001024912), a Geometrical Lantern (1001026833) and a 3 x 6 Indoor/Outdoor LED candle (1000848558) inside the lantern. These are suggestions; if your store does not have these exact items, please use similar articles.
- [Hang Tags] Attach hang tags to product display using zip tie.



PROTOTYPICAL

Sign Planogram: Patio

Bay Name: Patio Accessories 3.1

EFFECTIVE:

Jan 1, 2017

PAGE:

22 of 40

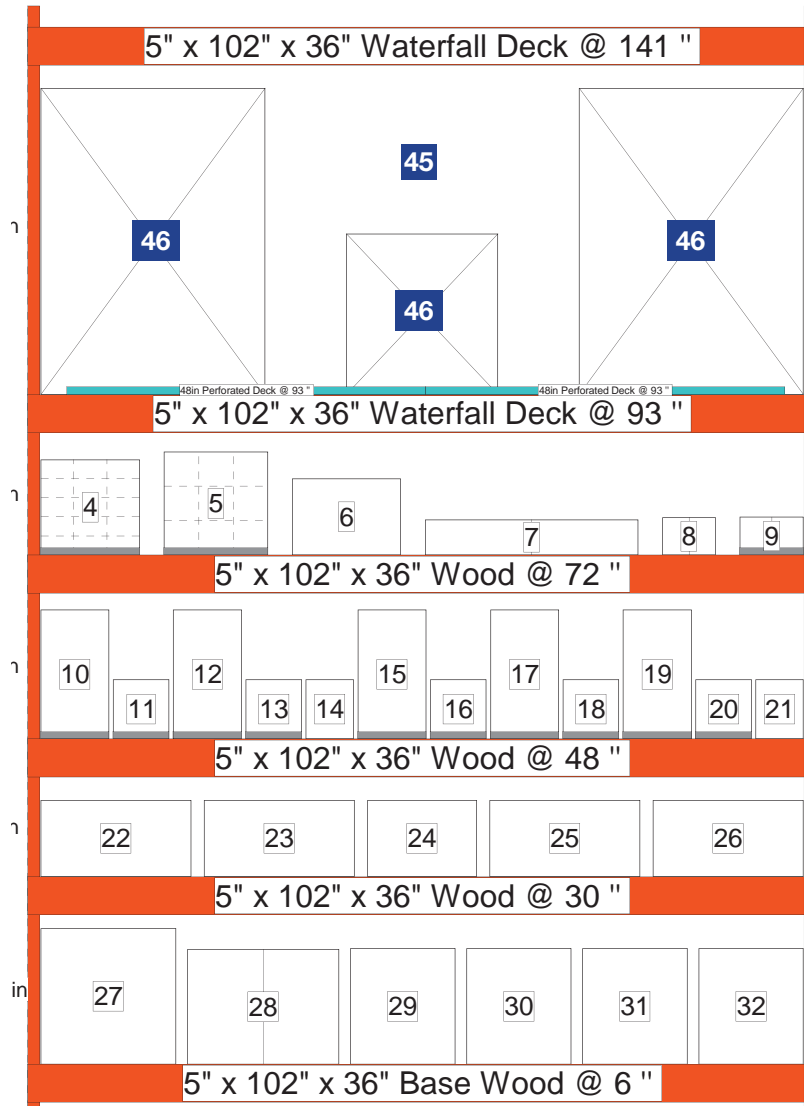

In Bay Signage Requirements

Item #	Part #	Description	Quantity	HD Article #	Hardware Requirements	How to Order
45	HD2800002_077E	Find MORE Patio Banner	1	-	Zip Ties	ePOP
46	HD2800002_025E	3-Pc Set Product Card - 2 Chairs / 1 Table included	1	1001023108	Zip Ties	ePOP
WF	Varies by bay ID #	Wayfinding Violator	1	-	Wayfinding Clip	ePOP
-	124-300TESA	Wayfinding Clip	1	-	-	ePOP
	GA002C	Zip Ties	Varies	-	-	ePOP

Merchandising POG shown is for POP reference only and is not to be used to set product. Refer to your store specific Merchandise POG for product placement.



PROTOTYPICAL

Sign Planogram: Patio

Bay Name: Patio Accessories 3.2

EFFECTIVE:

Jan 1, 2017

PAGE:

23 of 40



Please ensure the lights are not overlapping.



WF Wayfinding bay number must correspond to bay ID label



71" from floor to bottom of Wayfinding Violator

Instructions:

- [Wayfinding Violator] Install Wayfinding Violator using wayfinding clip so bottom edge is 71" above the floor
- [Banner] Attach banner to uprights using zip ties through grommets in corners
- [Light Strings] Choose 6 lights from these suggested items (or others if your store does not have these exact articles): 30 FT. Weatherproof String lights (1001002572), Hood and Cage Decorative 10-Light Set (1001025314), the 10-Light G50 Globes (1001025312), Decorative 10-Light String PSSO Clear Edison Bulbs (1001025313) and Set of 8 Decorative Patio Lights Caged Café Lights (1001025315). Ensure that the lights are not overlapping, and alternate between caged lights and non-caged lights to avoid a cluttered look.



PROTOTYPICAL

Sign Planogram: Patio
Bay Name: Patio Accessories 3.2

EFFECTIVE:

Jan 1, 2017

PAGE:

24 of 40

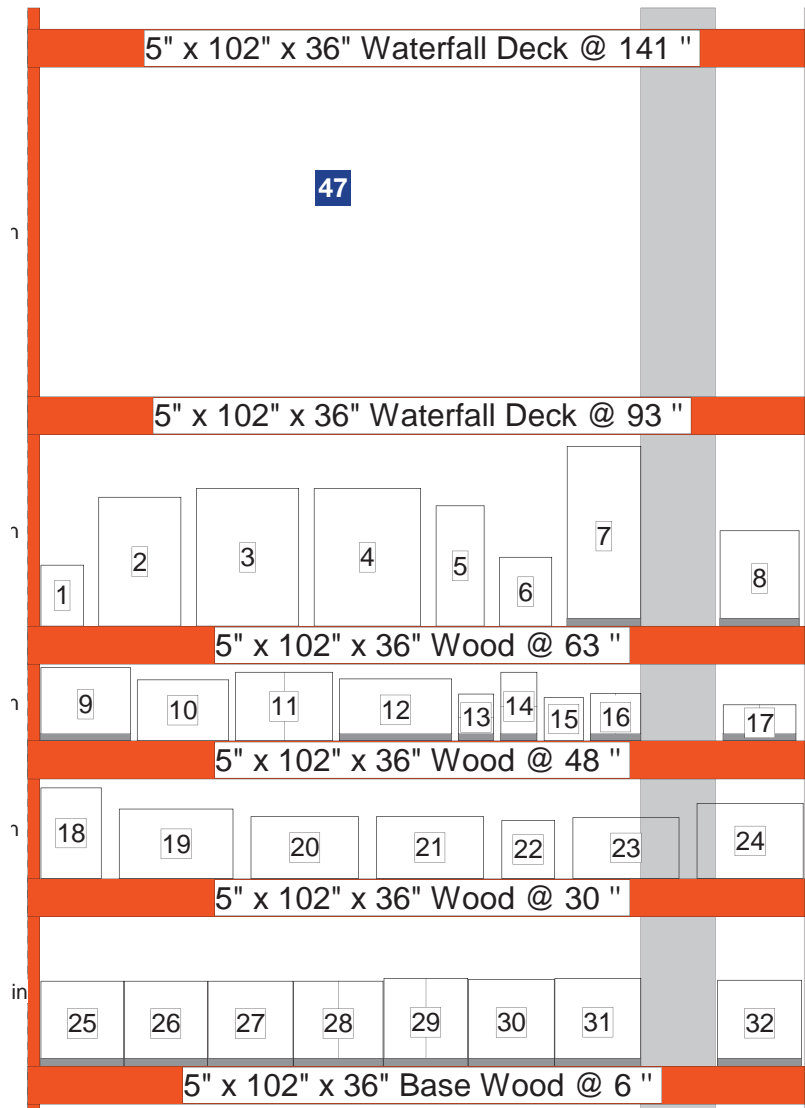

In Bay Signage Requirements

Item #	Part #	Description	Quantity	HD Article #	Hardware Requirements	How to Order
47	HD2800002_078E	Find MORE Lighting Banner	1	-	Zip Ties	ePOP
WF	Varies by bay ID #	Wayfinding Violator	1	-	Wayfinding Clip	ePOP
-	124-300TESA	Wayfinding Clip	1	-	-	ePOP
-	GA002C	Zip Ties	Varies	-	-	ePOP

Merchandising POG shown is for POP reference only and is not to be used to set product. Refer to your store specific Merchandise POG for product placement.



PROTOTYPICAL

Sign Planogram: Patio Bay Name: Patio Accessories 3.3

EFFECTIVE:

Jan 1, 2017

PAGE:

25 of 40

WF Wayfinding bay number must correspond to bay ID label



Wayfinding Clip

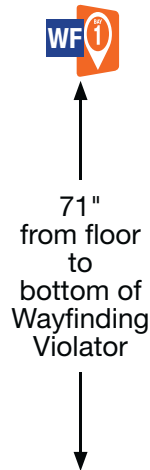

Instructions:

- [Wayfinding Violator] Install Wayfinding Violator using wayfinding clip so bottom edge is 71" above the floor



PROTOTYPICAL

Sign Planogram: Patio

Bay Name: Patio Accessories 3.3

EFFECTIVE:

Jan 1, 2017

PAGE:

26 of 40

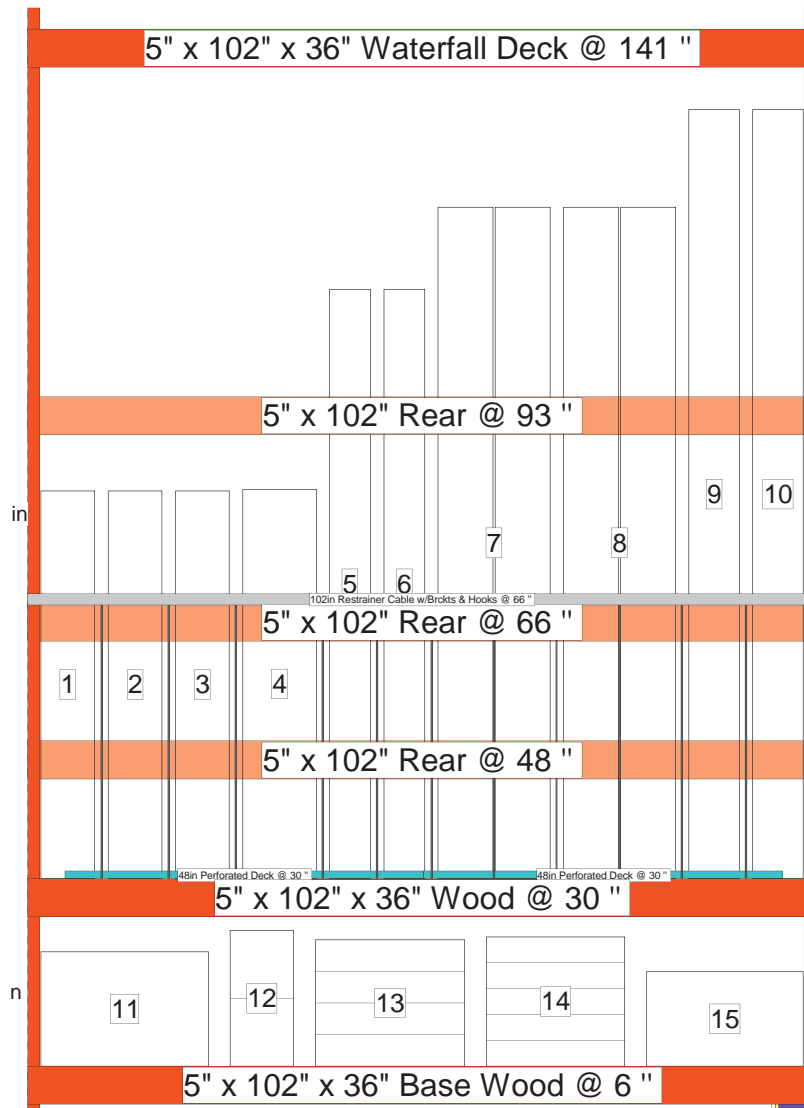

In Bay Signage Requirements

Item #	Part #	Description	Quantity	HD Article #	Hardware Requirements	How to Order
WF	Varies by bay ID #	Wayfinding Violator	1	-	Wayfinding Clip	ePOP
-	124-300TESA	Wayfinding Clip	1	-	-	ePOP

Merchandising POG shown is for POP reference only and is not to be used to set product. Refer to your store specific Merchandise POG for product placement.



PROTOTYPICAL

Sign Planogram: Patio Bay Name: Patio Cushions 3.1

EFFECTIVE:

Jan 1, 2017

PAGE:

27 of 40

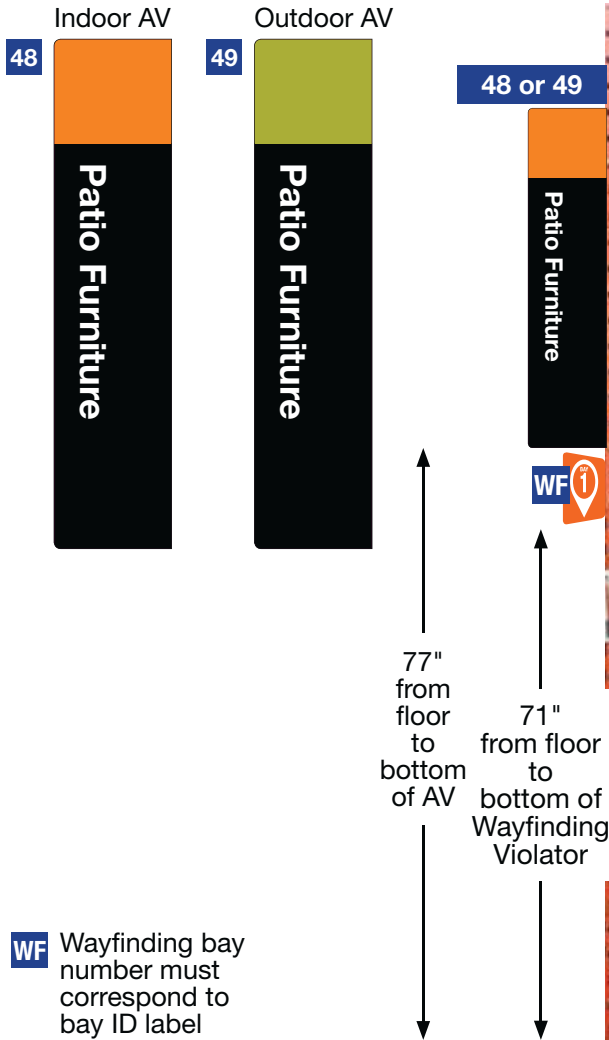

WF Wayfinding bay number must correspond to bay ID label



Note: Styles and colours have been updated since these bays were set at the IC.

Note: Wayfinding is NOT to be used in the Outdoor Garden Centre

Instructions:

- [Aisle Violators] Install Aisle Violator using AV clips so bottom edge is 77" above the floor
- [Wayfinding Violator] Install Wayfinding Violator using wayfinding clip so bottom edge is 71" above the floor



PROTOTYPICAL

**Sign Planogram: Patio
Bay Name: Patio Cushions 3.1**

EFFECTIVE:

Jan 1 2017

PAGE:

28 of 40

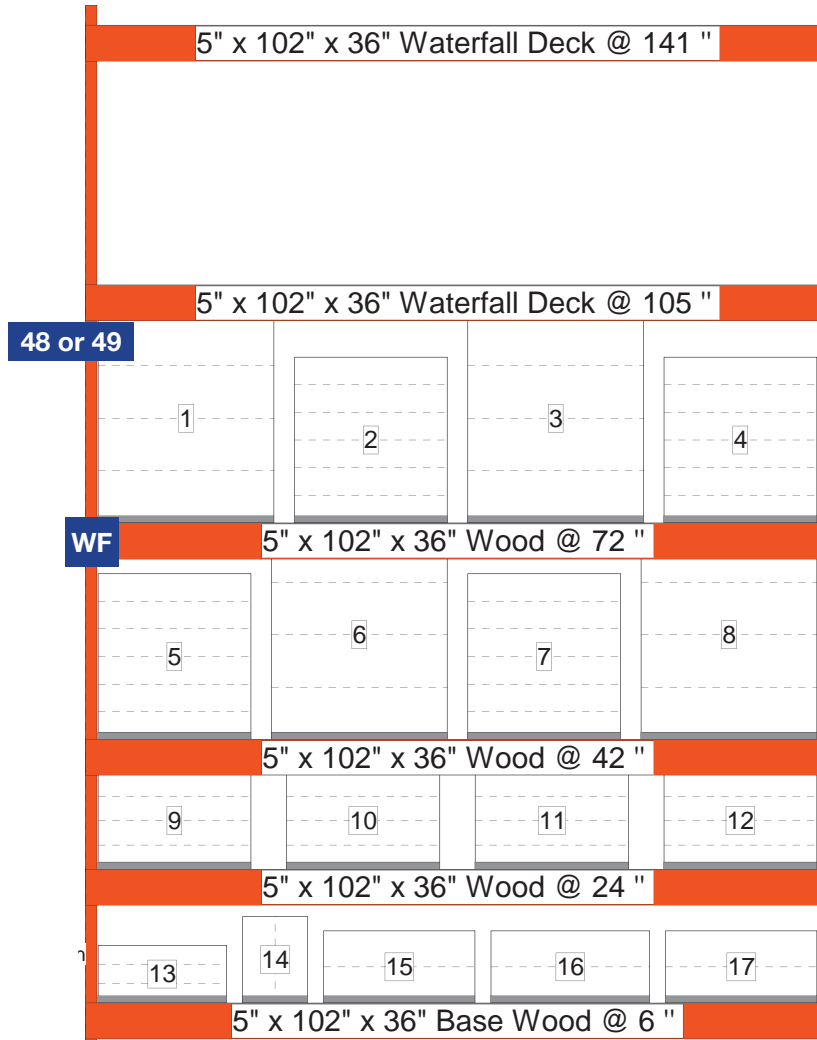

In Bay Signage Requirements

Item #	Part #	Description	Quantity	HD Article #	Hardware Requirements	How to Order
48	NWADSD508A-1	Patio Furniture Indoor - Aisle Violator	1	-	AV Clips	ePOP
49	NWADSD508B-2	Patio Furniture Outdoor - Aisle Violator	1	-	AV Clips	ePOP
WF	Varies by bay ID #	Wayfinding Violator	1	-	Wayfinding Clip	ePOP
-	124-300TESA	Wayfinding Clip	1	-	-	ePOP
	GA001C	AV Clips	2	-	-	ePOP

Merchandising POG shown is for POP reference only and is not to be used to set product. Refer to your store specific Merchandise POG for product placement.



PROTYPICAL

Sign Planogram: Patio Bay Name: Patio Cushions 3.2

EFFECTIVE:

Jan 1, 2017

PAGE:

29 of 40

WF Wayfinding bay number must correspond to bay ID label



Wayfinding Clip

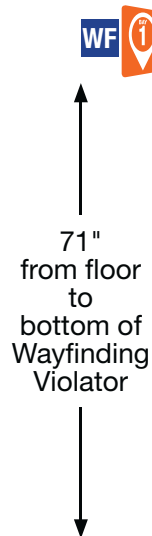

Note: Styles and colours have been updated since these bays were set at the IC.

Instructions:

- [Wayfinding Violator] Install Wayfinding Violator using wayfinding clip so bottom edge is 71" above the floor



PROTOTYPICAL

**Sign Planogram: Patio
Bay Name: Patio Cushions 3.2**

EFFECTIVE:

Jan 1 2017

PAGE:

30 of 40

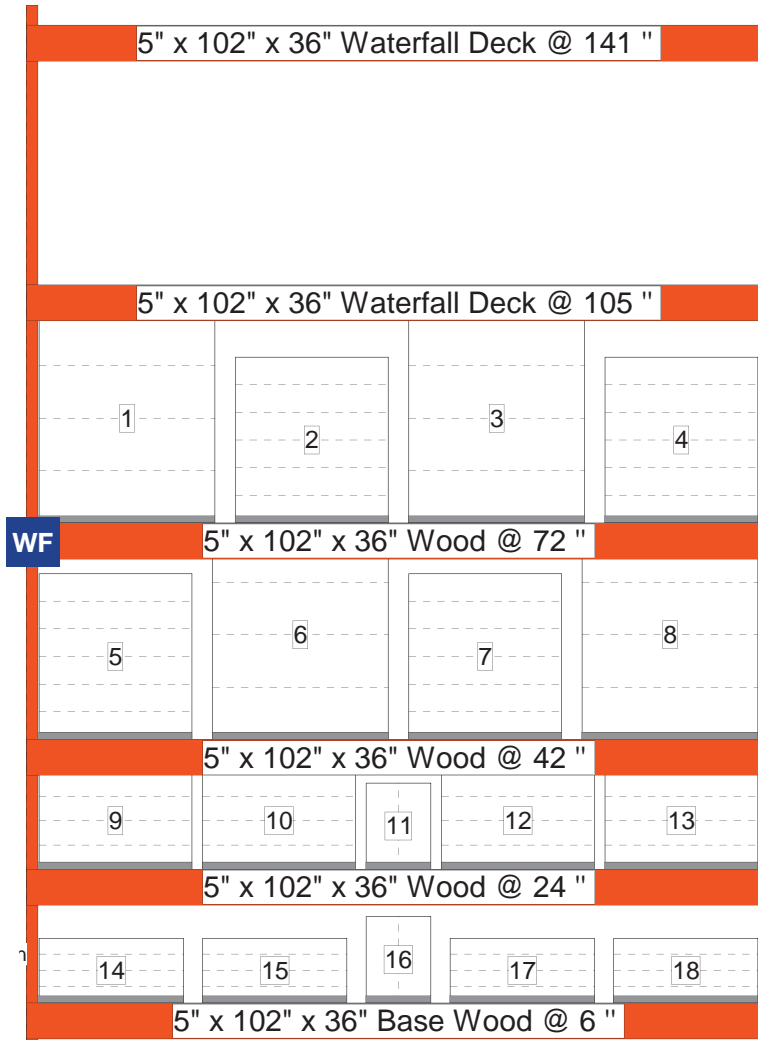

In Bay Signage Requirements

Item #	Part #	Description	Quantity	HD Article #	Hardware Requirements	How to Order
WF	Varies by bay ID #	Wayfinding Violator	1	-	Wayfinding Clip	ePOP
-	124-300TESA	Wayfinding Clip	1	-	-	ePOP

Merchandising POG shown is for POP reference only and is not to be used to set product. Refer to your store specific Merchandise POG for product placement.



PROTOTYPICAL

Sign Planogram: Patio Bay Name: Patio Cushions 3.3

EFFECTIVE:

Jan 1, 2017

PAGE:

31 of 40

WF Wayfinding bay number must correspond to bay ID label



Wayfinding Clip

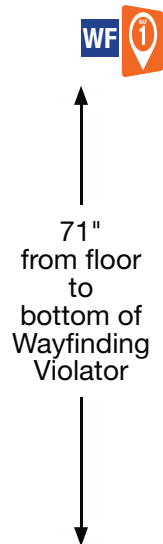

Note: Styles and colours have been updated since these bays were set at the IC.

Instructions:

- [Wayfinding Violator] Install Wayfinding Violator using wayfinding clip so bottom edge is 71" above the floor



PROTOTYPICAL

**Sign Planogram: Patio
Bay Name: Patio Cushions 3.3**

EFFECTIVE:

Jan 1 2017

PAGE:

32 of 40

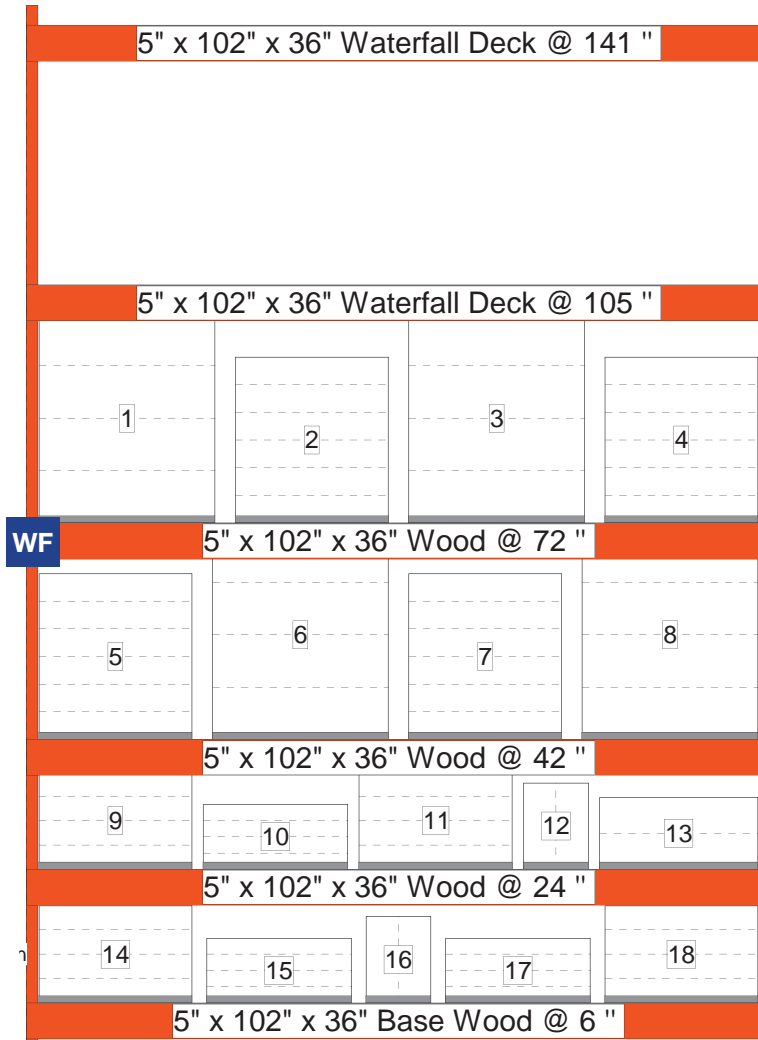

In Bay Signage Requirements

Item #	Part #	Description	Quantity	HD Article #	Hardware Requirements	How to Order
WF	Varies by bay ID #	Wayfinding Violator	1	-	Wayfinding Clip	ePOP
-	124-300TESA	Wayfinding Clip	1	-	-	ePOP

Merchandising POG shown is for POP reference only and is not to be used to set product. Refer to your store specific Merchandise POG for product placement.



PROTOTYPICAL

Sign Planogram: Patio Bay Name: Patio Stock 4.1

EFFECTIVE:

Jan 1, 2017

PAGE:

33 of 40

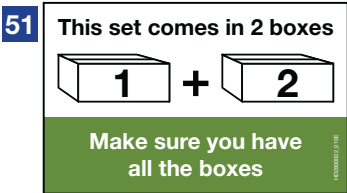

Use this POP where needed/ applicable

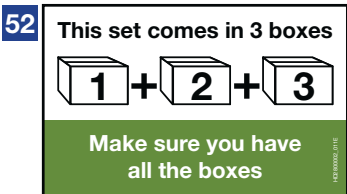

Use this POP where needed/ applicable

WF Wayfinding bay number must correspond to bay ID label



71"
from floor
to
bottom of
Wayfinding
Violator

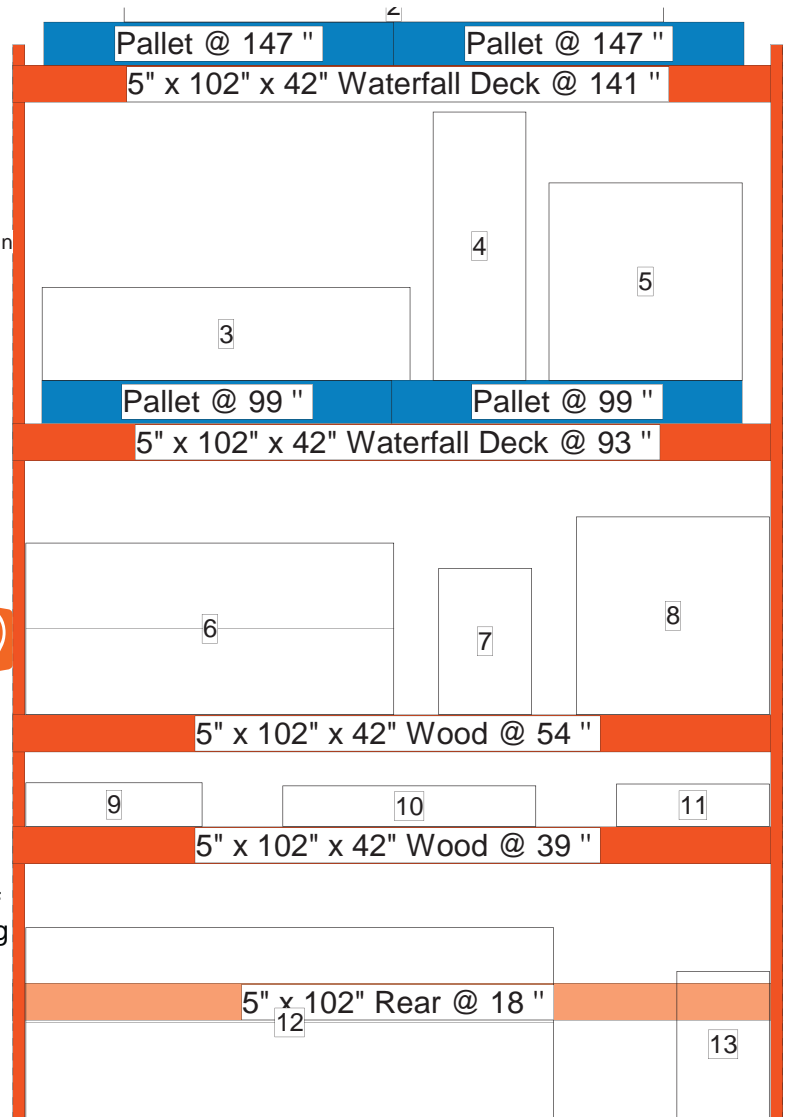

Instructions:

- [Wayfinding Violator] Install Wayfinding Violator using wayfinding clip so bottom edge is 71" above the floor
- [Beam Labels] Remove any old beam labels (if applicable) and place label on the beam below the applicable product
- [Beam Labels - Bottom Elevation] For products on bottom shelf, attach clear pallet tag to bottom of beam, above the product, and apply label to it



PROTOTYPICAL

Sign Planogram: Patio Bay Name: Patio Stock 4.1

EFFECTIVE:

Jan 1, 2017

PAGE:

34 of 40

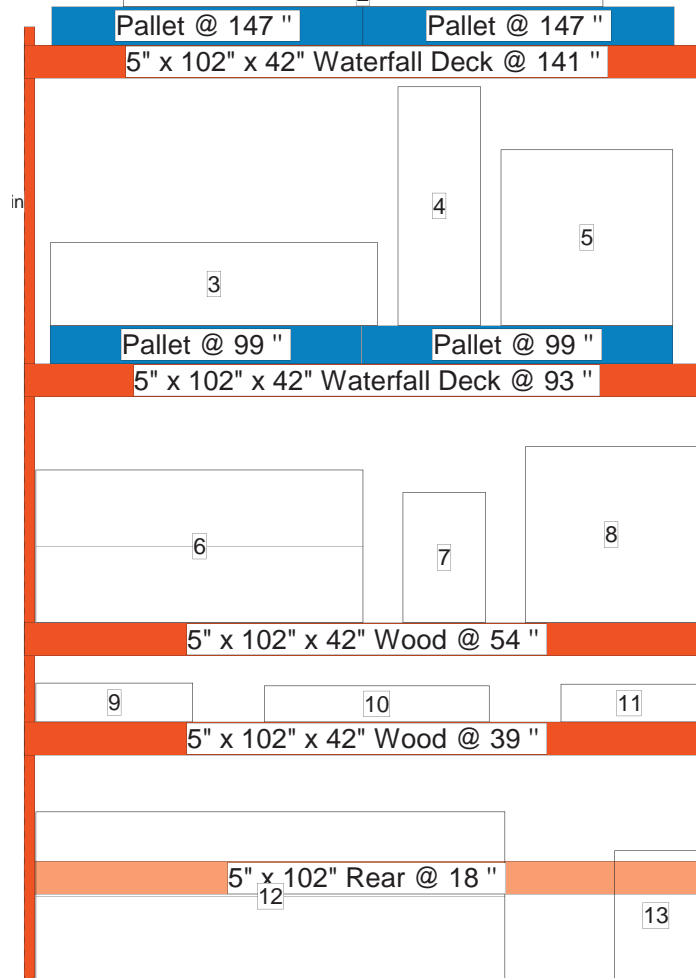

In Bay Signage Requirements

Item #	Part #	Description	Quantity	HD Article #	Hardware Requirements	How to Order
50	HD2800002_024E	Heavy Box Label	1	-	-	ePOP
51	HD2800002_010E	2 Box Set Label	1	-	-	ePOP
52	HD2800002_011E	3 Box Set Label	1	-	-	ePOP
WF	Varies by bay ID #	Wayfinding Violator	1	-	Wayfinding Clip	ePOP
-	124-300TESA	Wayfinding Clip	1	-	-	ePOP

Merchandising POG shown is for POP reference only and is not to be used to set product. Refer to your store specific Merchandise POG for product placement.



PROTOTYPICAL

Sign Planogram: Patio Bay Name: Patio Stock 4.2

EFFECTIVE:

Jan 1, 2017

PAGE:

35 of 40

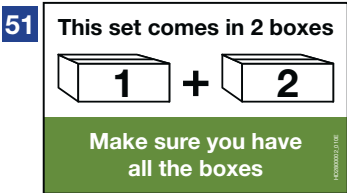

Use this POP where needed/ applicable

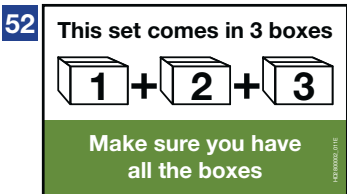

Use this POP where needed/ applicable

WF Wayfinding bay number must correspond to bay ID label

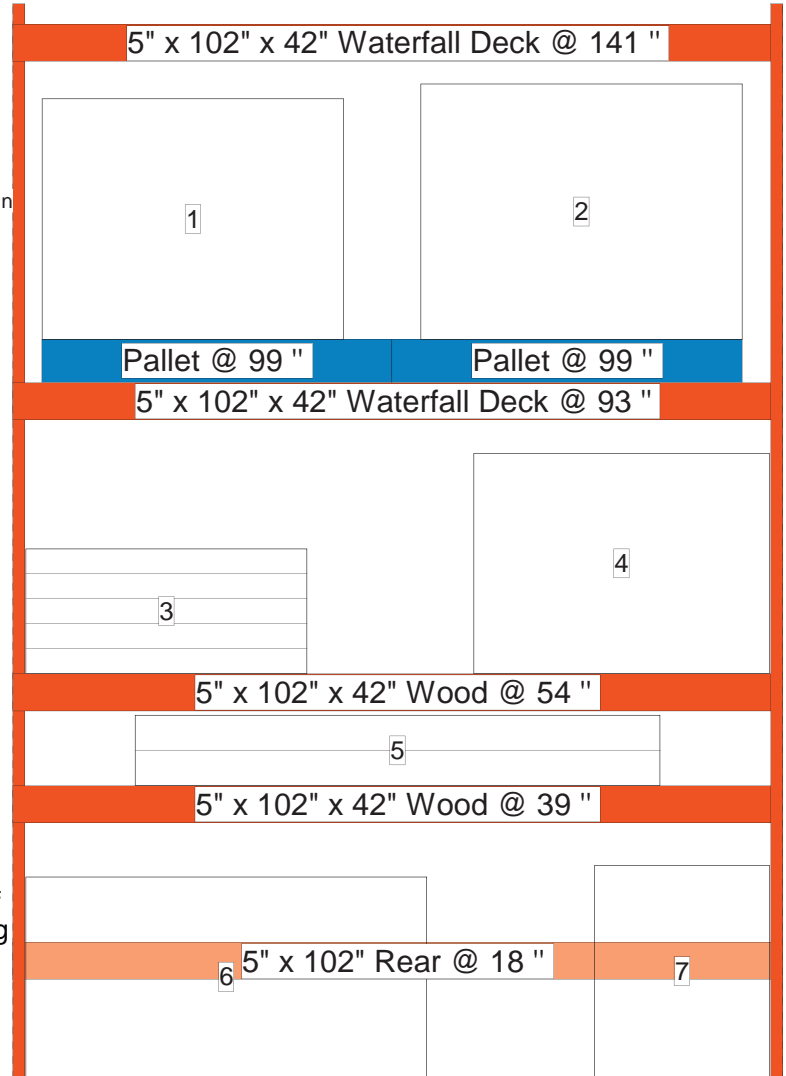
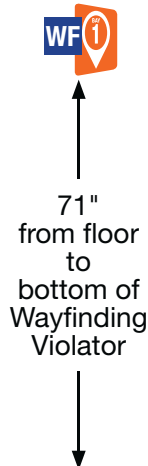

Instructions:

- [Wayfinding Violator] Install Wayfinding Violator using wayfinding clip so bottom edge is 71" above the floor
- [Beam Labels] Remove any old beam labels (if applicable) and place label on the beam below the applicable product
- [Beam Labels - Bottom Elevation] For products on bottom shelf, attach clear pallet tag to bottom of beam, above the product, and apply label to it



PROTOTYPICAL

**Sign Planogram: Patio
Bay Name: Patio Stock 4.2**

EFFECTIVE:

Jan 1, 2017

PAGE:

36 of 40

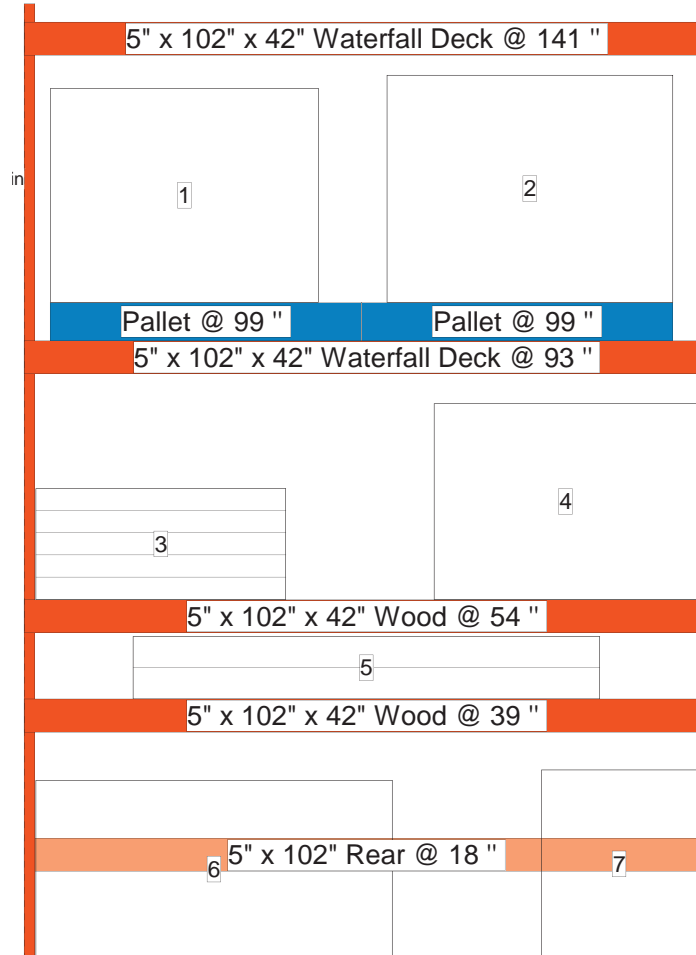

In Bay Signage Requirements

Item #	Part #	Description	Quantity	HD Article #	Hardware Requirements	How to Order
50	HD2800002_024E	Heavy Box Label	1	-	-	ePOP
51	HD2800002_010E	2 Box Set Label	1	-	-	ePOP
52	HD2800002_011E	3 Box Set Label	1	-	-	ePOP
WF	Varies by bay ID #	Wayfinding Violator	1	-	Wayfinding Clip	ePOP
-	124-300TESA	Wayfinding Clip	1	-	-	ePOP

Merchandising POG shown is for POP reference only and is not to be used to set product. Refer to your store specific Merchandise POG for product placement.



PROTOTYPICAL

Sign Planogram: Patio Bay Name: Patio Stock 4.3

EFFECTIVE:

Jan 1, 2017

PAGE:

37 of 40

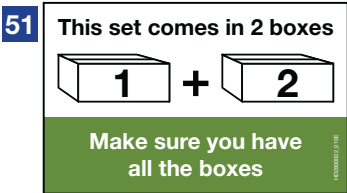

Use this POP where needed/ applicable

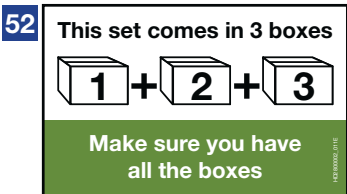

Use this POP where needed/ applicable

WF Wayfinding bay number must correspond to bay ID label



WF 
71"
from floor
to
bottom of
Wayfinding
Violator

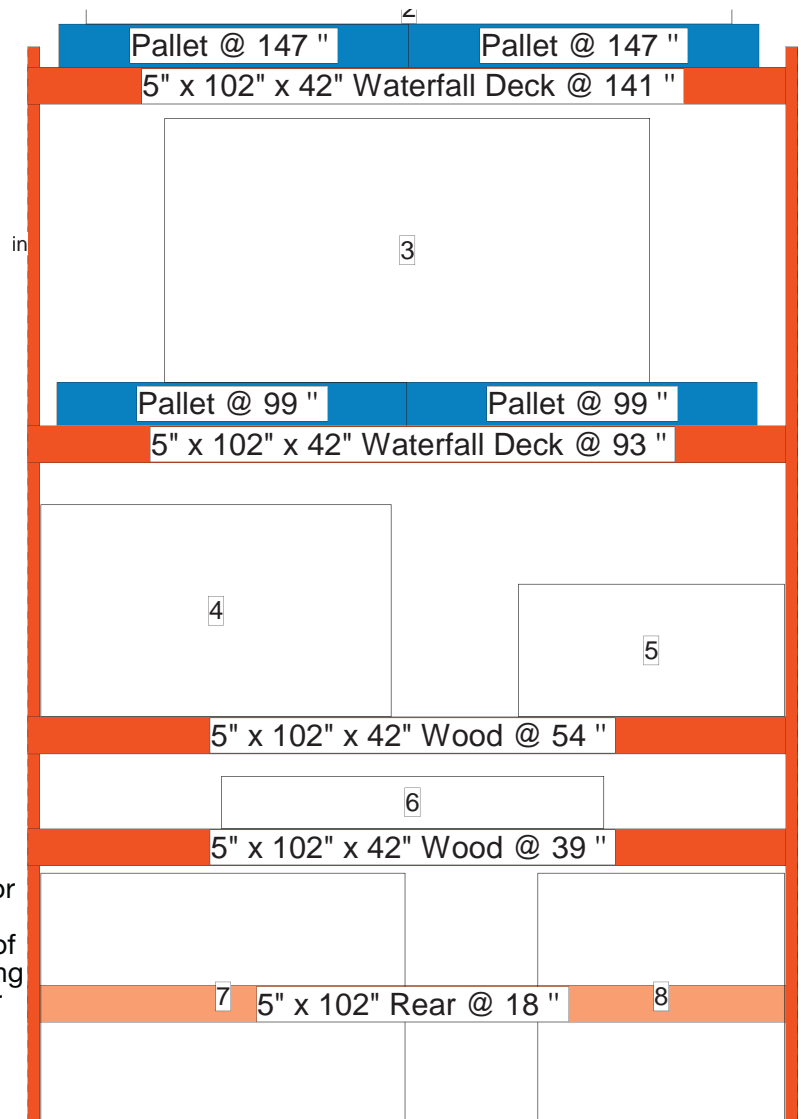

Instructions:

- [Wayfinding Violator] Install Wayfinding Violator using wayfinding clip so bottom edge is 71" above the floor
- [Beam Labels] Remove any old beam labels (if applicable) and place label on the beam below the applicable product
- [Beam Labels - Bottom Elevation] For products on bottom shelf, attach clear pallet tag to bottom of beam, above the product, and apply label to it



PROTOTYPICAL

Sign Planogram: Patio Bay Name: Patio Stock 4.3

EFFECTIVE:

Jan 1, 2017

PAGE:

38 of 40

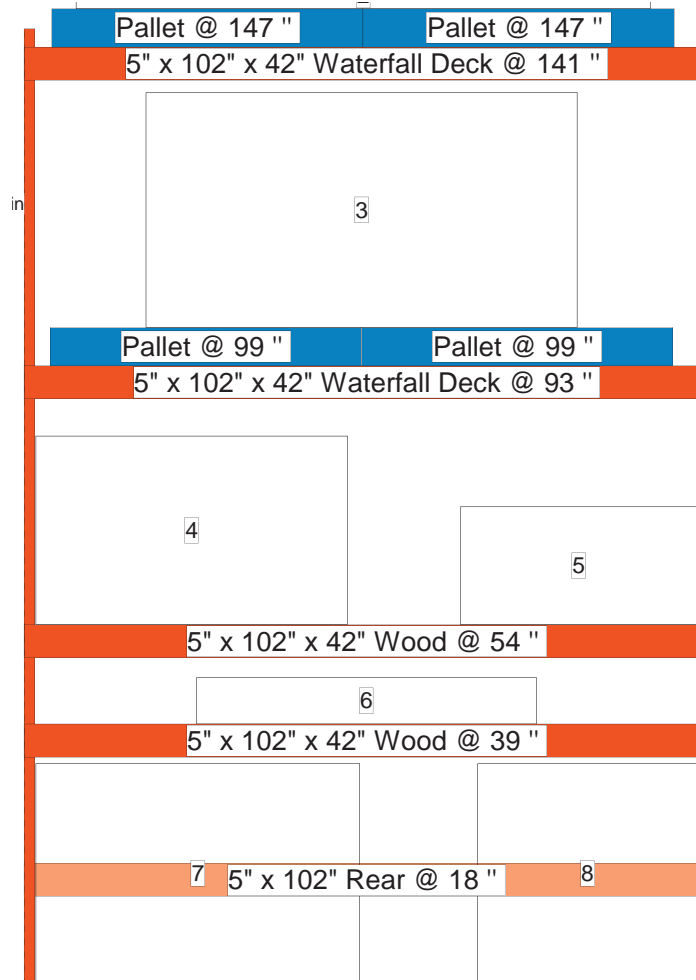

In Bay Signage Requirements

Item #	Part #	Description	Quantity	HD Article #	Hardware Requirements	How to Order
50	HD2800002_024E	Heavy Box Label	1	-	-	ePOP
51	HD2800002_010E	2 Box Set Label	1	-	-	ePOP
52	HD2800002_011E	3 Box Set Label	1	-	-	ePOP
WF	Varies by bay ID #	Wayfinding Violator	1	-	Wayfinding Clip	ePOP
-	124-300TESA	Wayfinding Clip	1	-	-	ePOP

Merchandising POG shown is for POP reference only and is not to be used to set product. Refer to your store specific Merchandise POG for product placement.



PROTOTYPICAL

Sign Planogram: Patio Bay Name: Patio Stock 4.4

EFFECTIVE:

Jan 1, 2017

PAGE:

39 of 40

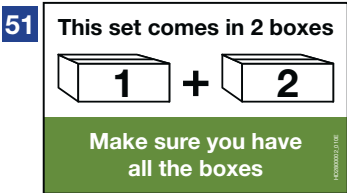

Use this POP where needed/ applicable

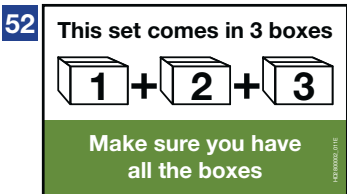

Use this POP where needed/ applicable

WF Wayfinding bay number must correspond to bay ID label



WF 
71"
from floor
to
bottom of
Wayfinding
Violator

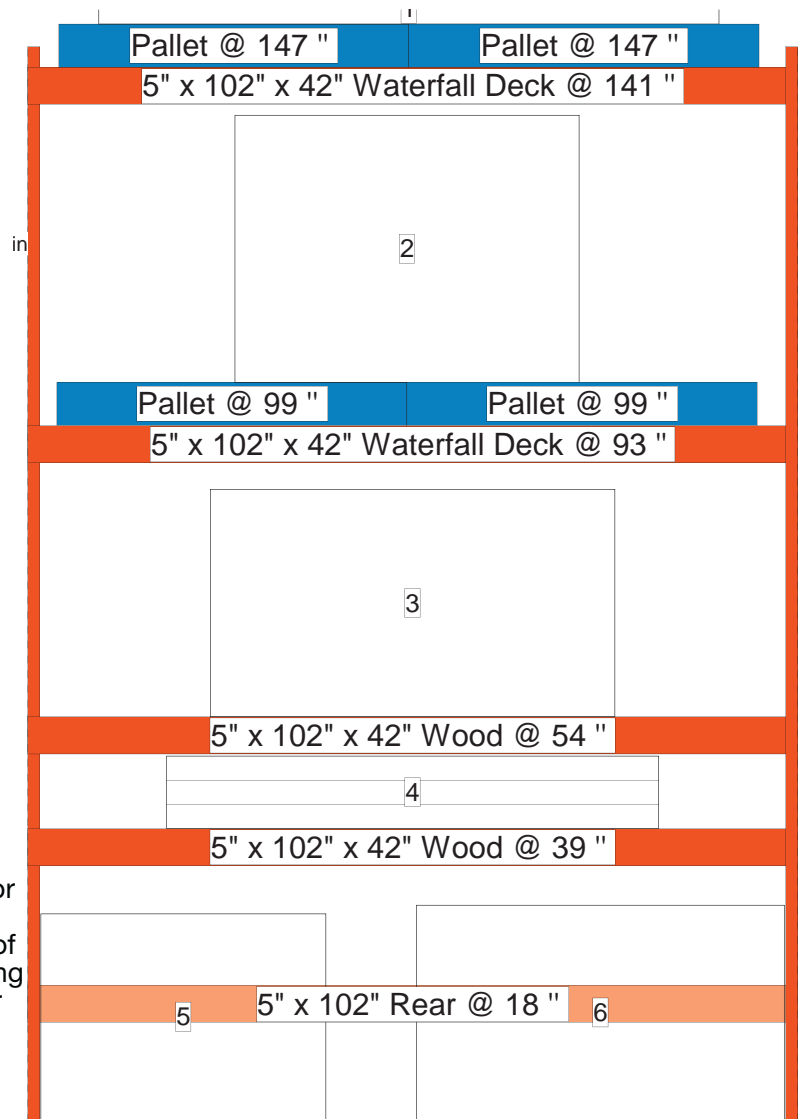

Instructions:

- [Wayfinding Violator] Install Wayfinding Violator using wayfinding clip so bottom edge is 71" above the floor
- [Beam Labels] Remove any old beam labels (if applicable) and place label on the beam below the applicable product
- [Beam Labels - Bottom Elevation] For products on bottom shelf, attach clear pallet tag to bottom of beam, above the product, and apply label to it



PROTOTYPICAL

Sign Planogram: Patio Bay Name: Patio Stock 4.4

EFFECTIVE:

Jan 1, 2017

PAGE:

40 of 40

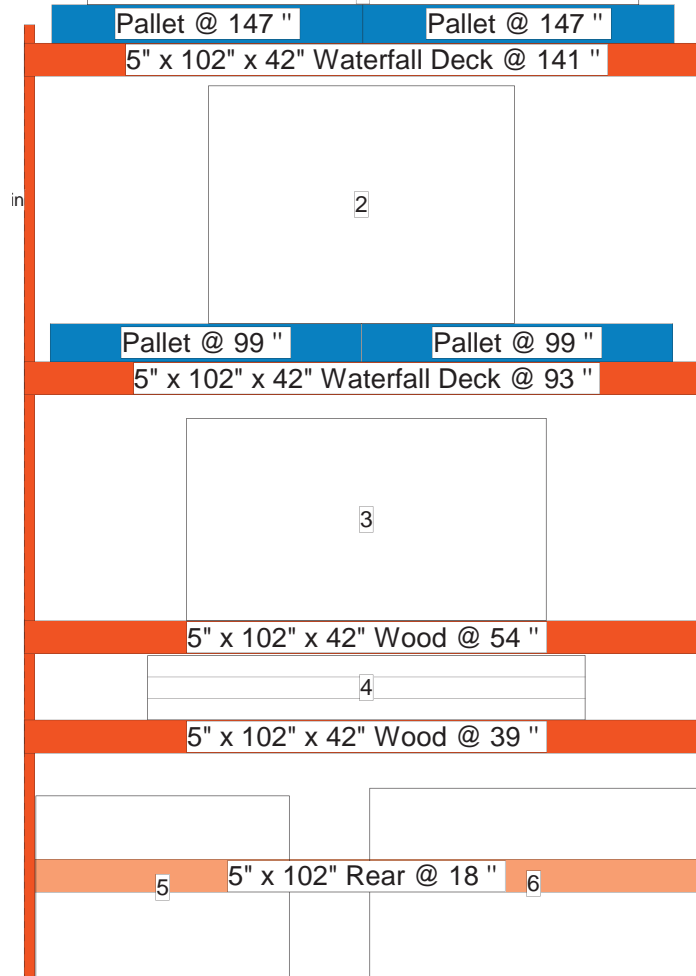

In Bay Signage Requirements

Item #	Part #	Description	Quantity	HD Article #	Hardware Requirements	How to Order
50	HD2800002_024E	Heavy Box Label	1	-	-	ePOP
51	HD2800002_010E	2 Box Set Label	1	-	-	ePOP
52	HD2800002_011E	3 Box Set Label	1	-	-	ePOP
WF	Varies by bay ID #	Wayfinding Violator	1	-	Wayfinding Clip	ePOP
-	124-300TESA	Wayfinding Clip	1	-	-	ePOP

Merchandising POG shown is for POP reference only and is not to be used to set product. Refer to your store specific Merchandise POG for product placement.